

**ARM<sup>®</sup> Cortex<sup>®</sup>-M0**  
**32-bit Microcontroller**

**NuMicro<sup>®</sup> Family**  
**NuTiny-SDK-NANO120**  
**User Manual**

*The information described in this document is the exclusive intellectual property of Nuvoton Technology Corporation and shall not be reproduced without permission from Nuvoton.*

*Nuvoton is providing this document only for reference purposes of NuMicro microcontroller based system design. Nuvoton assumes no responsibility for errors or omissions.*

*All data and specifications are subject to change without notice.*

For additional information or questions, please contact: Nuvoton Technology Corporation.

[www.nuvoton.com](http://www.nuvoton.com)

**Table of Contents**

1 OVERVIEW ..... 3

2 NUTINY-SDK-NANO120 INTRODUCTION..... 4

    2.1 NuTiny -SDK-NANO120 Jumper Description ..... 5

        2.1.1 Power Setting ..... 5

        2.1.2 Debug Connector ..... 5

        2.1.3 USB Connector ..... 5

        2.1.4 Extended Connector ..... 5

        2.1.5 Reset Button ..... 5

        2.1.6 Power Connector ..... 5

    2.2 Pin Assignment for Extended Connector ..... 6

    2.3 NuTiny-SDK-NANO120 PCB Placement ..... 9

3 How to Start NuTiny-SDK-NANO120 on the Keil  $\mu$ Vision<sup>®</sup> IDE ..... 10

    3.1 Keil uVision<sup>®</sup> IDE Software Download and Install ..... 10

    3.2 Nuvoton Nu-Link Driver Download and Install ..... 10

    3.3 Hardware Setup ..... 10

    3.4 Example Program ..... 11

4 How to Start NuTiny-SDK-NANO120 on the IAR Embedded Workbench ..... 12

    4.1 IAR Embedded Workbench Software Download and Install ..... 12

    4.2 Nuvoton Nu-Link Driver Download and Install ..... 12

    4.3 Hardware Setup ..... 12

    4.4 Example Program ..... 13

5 NuTiny-SDK-NANO120 Schematic ..... 14

    5.1 NuTiny-EVB-NANO120 Schematic ..... 14

    5.2 GPIO for 128 pin Schematic ..... 15

    5.3 Nu-Link-Me Schematic ..... 16

6 REVISION HISTORY ..... 17

## 1 OVERVIEW

NuTiny-SDK-NANO120 is the specific development tool for NuMicro® NANO120 series. Users can use NuTiny-SDK-NANO120 to develop and verify the application program easily.

NuTiny-SDK-NANO120 includes two portions. One is NuTiny-EVB-NANO120 and the other is Nu-Link-Me. NuTiny-EVB-NANO120 is the evaluation board and Nu-Link-Me is its Debug Adaptor. Thus, users do not need other additional ICE or debug equipments.

## 2 NUTINY-SDK-NANO120 INTRODUCTION

NuTiny-SDK-NANO120 uses the NANO120KE3BN as the target microcontroller. Figure 2-1 is NuTiny-SDK-NANO120 for NANO120 series, the left portion is called NuTiny-EVB-NANO120 and the right portion is Debug Adaptor called Nu-Link-Me.

NuTiny-EVB-NANO120 is similar to other development boards. Users can use it to develop and verify applications to emulate the real behavior. The on board chip covers NANO120 series features. The NuTiny-EVB-NANO120 can be a real system controller to design users' target systems.

The Nu-Link-Me is a Debug Adaptor. The Nu-Link-Me Debug Adaptor connects your PC's USB port to your target system (via Serial Wired Debug Port) and allows you to program and debug embedded programs on the target hardware. To use Nu-Link-Me Debug adaptor with IAR or Keil, please refer to "Nuvoton NuMicro® IAR ICE driver user manual" or "Nuvoton NuMicro® Keil ICE driver user manual" in detail. These two documents will be stored in the local hard disk when the user installs each driver.

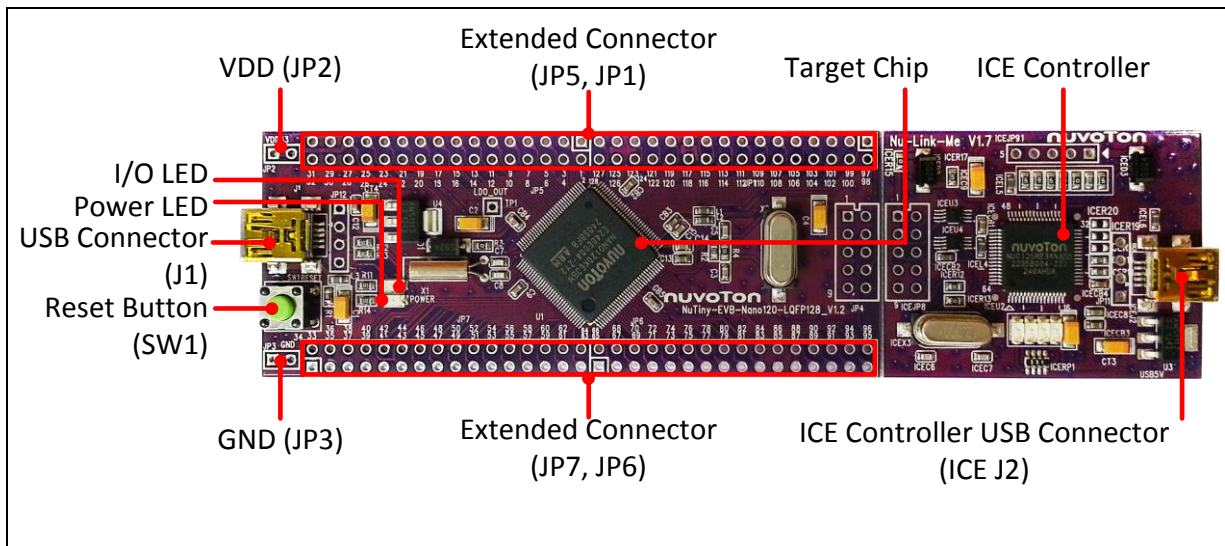

Figure 2-1 NuTiny-SDK-NANO120 (PCB Board)

## 2.1 NuTiny -SDK-NANO120 Jumper Description

### 2.1.1 Power Setting

- JP2:  $V_{DD}$  Voltage connector in NuTiny-EVB-NANO120
- ICE J2: USB port in Nu-Link-Me

Model	JP2 $V_{DD}$	ICE J2 ICE USB Port	MCU Voltage
Model 1	DC 3.3V Output	Connect to PC	DC 3.3V
Model 2	DC 1.8V ~ 3.6V Input	X	Voltage by JP2 Input

X: Unused.

### 2.1.2 Debug Connector

- JP4: Connector in target board (NuTiny-EVB-NANO120) for connecting with Nuvoton ICE adaptor (Nu-Link-Me)
- ICE JP8: Connector in ICE adaptor (Nu-Link-Me) for connecting with a target board (NuTiny-EVB-NANO120)

### 2.1.3 USB Connector

- J1: Micro USB Connector in NuTiny-EVB-NANO120 connected to a PC USB port
- ICE J2: Micro USB Connector in Nu-Link-Me connected to a PC USB port

### 2.1.4 Extended Connector

- JP1, JP5, JP6, and JP7: Show all chip pins in NuTiny-EVB-NANO120

### 2.1.5 Reset Button

- SW1: Reset button in NuTiny-EVB-NANO120

### 2.1.6 Power Connector

- JP2:  $V_{DD}$  connector in NuTiny-EVB-NANO120
- JP3: GND connector in NuTiny-EVB-NANO120

## 2.2 Pin Assignment for Extended Connector

NuTiny-EVB-NANO120 provides NANO120KE3BN on board and the extended connector for LQFP128-pin. Table 2-1 is the pin assignment for NANO120KE3BN.

Pin No	Pin Name	Pin No	Pin Name
1	PE.13	65	PE.4/SPI0_MOSI0
2	PB.14/INT0/SC2_CD/SPI2_SS1	66	PE.3/SPI0_MISO0
3	PB.13/EBI_AD1	67	PE.2/SPI0_CLK
4	PB.12/EBI_AD0/FCLKO	68	PE.1/PWM1_CH3/SPI0_SS0
5	NC	69	PE.0/PWM1_CH2/I2S_MCLK
6	X32_OUT	70	PC.13/SPI1_MOSI1/PWM1_CH1/SNOO PER/INT1/I2C0_SCL
7	X32_IN	71	PC.12/SPI1_MISO1/PWM1_CH0/INT0/I 2C0_SDA
8	NC	72	PC.11/SPI1_MOSI0/UART1_TXD
9	PA.11/I2C1_SCL/EBI_nRD/SC0_RST/S PI2_MOSI0	73	PC.10/SPI1_MISO0/UART1_RXD
10	PA.10/I2C1_SDA/EBI_nWR/SC0_PWR/ SPI2_MISO0	74	PC.9/SPI1_CLK/I2C1_SCL
11	PA.9/I2C0_SCL/SC0_DAT/SPI2_CLK	75	PC.8/SPI1_SS0/EBI_MCLK/I2C1_SDA
12	PA.8/I2C0_SDA/SC0_CLK/SPI2_SS0	76	PA.15/PWM0_CH3/I2S_MCLK/TC3/SC0 _PWR/UART0_TXD
13	PD.8	77	PA.14/PWM0_CH2/EBI_AD15/TC2/UAR T0_RXD
14	PD.9	78	PA.13/PWM0_CH1/EBI_AD14/TC1/I2C0 _SCL
15	PD.10	79	PA.12/PWM0_CH0/EBI_AD13/TC0/I2C0 _SDA
16	PD.11	80	PF.0/INT0/ICE_DAT
17	PD.12	81	PF.1/FCLKO/INT1/ICE_CLK
18	PD.13	82	NC
19	PB.4/UART1_RXD/SC0_CD/SPI2_SS0	83	VDD
20	PB.5/UART1_TXD/SC0_RST/SPI2_CLK	84	NC
21	PB.6/UART1_RTSn/EBI_ALE/SPI2_MIS OO	85	VSS
22	PB.7/UART1_CTSn/EBI_nCS/SPI2_MO SIO	86	VSS
23	NC	87	AVSS

24	LDO_CAP	88	AVSS
25	NC	89	PA.0/AD0/SC2_CD
26	NC	90	PA.1/AD1/EBI_AD12
27	VDD	91	PA.2/AD2/EBI_AD11/UART1_RXD
28	NC	92	PA.3/AD3/EBI_AD10/UART1_TXD
29	VSS	93	PA.4/AD4/EBI_AD9/SC2_PWR/I2C0_SDA
30	VSS	94	PA.5/AD5/EBI_AD8/SC2_RST/I2C0_SCL
31	VSS	95	PA.6/AD6/EBI_AD7/TC3/SC2_CLK/PWM0_CH3
32	VSS	96	PA.7/AD7/EBI_AD6/TC2/SC2_DAT/PWM0_CH2
33	PE.12	97	VREF
34	PE.11	98	NC
35	PE.10	99	AVDD
36	PE.9	100	PD.0/UART1_RXD/SPI2_SS0/SC1_CLK/AD8
37	PE.8	101	PD.1/UART1_TXD/SPI2_CLK/SC1_DAT/AD9
38	PE.7	102	PD.2/UART1_RTSn/I2S_LRCLK/SPI2_MISO0/SC1_PWR/AD10
39	NC	103	PD.3/UART1_CTSn/I2S_BCLK/SPI2_MOSI0/SC1_RST/AD11
40	USB_VBUS	104	NC
41	USB_VDD33_CAP	105	PD.4/I2S_DI/SPI2_MISO1/SC1_CD
42	USB_D-	106	PD.5/I2S_DO/SPI2_MOSI1
43	USB_D+	107	PC.7/DA1_OUT/EBI_AD5/TC1/PWM0_CH1
44	PB.0/UART0_RXD/SPI1_MOSI0	108	PC.6/DA0_OUT/EBI_AD4/TC0/SC1_CD/PWM0_CH0
45	PB.1/UART0_TXD/SPI1_MISO0	109	PC.15/EBI_AD3/TC0/PWM1_CH2
46	PB.2/UART0_RTSn/EBI_nWRL/SPI1_CLK	110	PC.14/EBI_AD2/PWM1_CH3
47	PB.3/UART0_CTSn/EBI_nWRH/SPI1_SS0	111	PB.15/INT1/SNOOPER/SC1_CD
48	PD.6	112	NC

49	PD.7	113	XT1_IN
50	PD.14	114	XT1_OUT
51	PD.15	115	NC
52	PC.5/SPI0_MOSI1	116	nRESET
53	PC.4/SPI0_MISO1	117	VSS
54	PC.3/SPI0_MOSI0/I2S_DO/SC1_RST	118	VSS
55	PC.2/SPI0_MISO0/I2S_DI/SC1_PWR	119	NC
56	PC.1/SPI0_CLK/I2S_BCLK/SC1_DAT	120	VDD
57	PC.0/SPI0_SS0/I2S_LRCLK/SC1_CLK	121	NC
58	PE.6	122	PF.4/I2C0_SDA
59	NC	123	PF.5/I2C0_SCL
60	NC	124	VSS
61	PE.5/PWM1_CH1	125	PVSS
62	PB.11/PWM1_CH0/TM3/SC2_DAT/SPI0_MISO0	126	PB.8/STADC/TM0/INT0/SC2_PWR
63	PB.10/SPI0_SS1/TM2/SC2_CLK/SPI0_MOSI0	127	PE.15
64	PB.9/SPI1_SS1/TM1/SC2_RST/INT0	128	PE.14

Table 2-1 Pin Assignment for NANO120





### 3 HOW TO START NUTINY-SDK-NANO120 ON THE KEIL MVISION® IDE

#### 3.1 Keil uVision® IDE Software Download and Install

Please visit the Keil company website (<http://www.keil.com>) to download the Keil  $\mu$ Vision® IDE and install the RVMDK.

#### 3.2 Nuvoton Nu-Link Driver Download and Install

Please visit the Nuvoton company NuMicro® website (<http://www.nuvoton.com/NuMicro>) to download “NuMicro® Keil  $\mu$ Vision® IDE driver” file. When the Nu-Link driver has been well downloaded, please unzip the file and execute the “Nu-Link\_Keil\_Driver.exe” to install the driver.

#### 3.3 Hardware Setup

The hardware setup is shown as Figure 3-1.



Figure 3-1 NuTiny-SDK-NANO120 Hardware Setup

### 3.4 Example Program

This example demonstrates the ease of downloading and debugging an application on a NuTiny-SDK-NANO120 board. It can be found on Figure 3-2 list directory and downloaded from Nuvoton NuMicro® website.

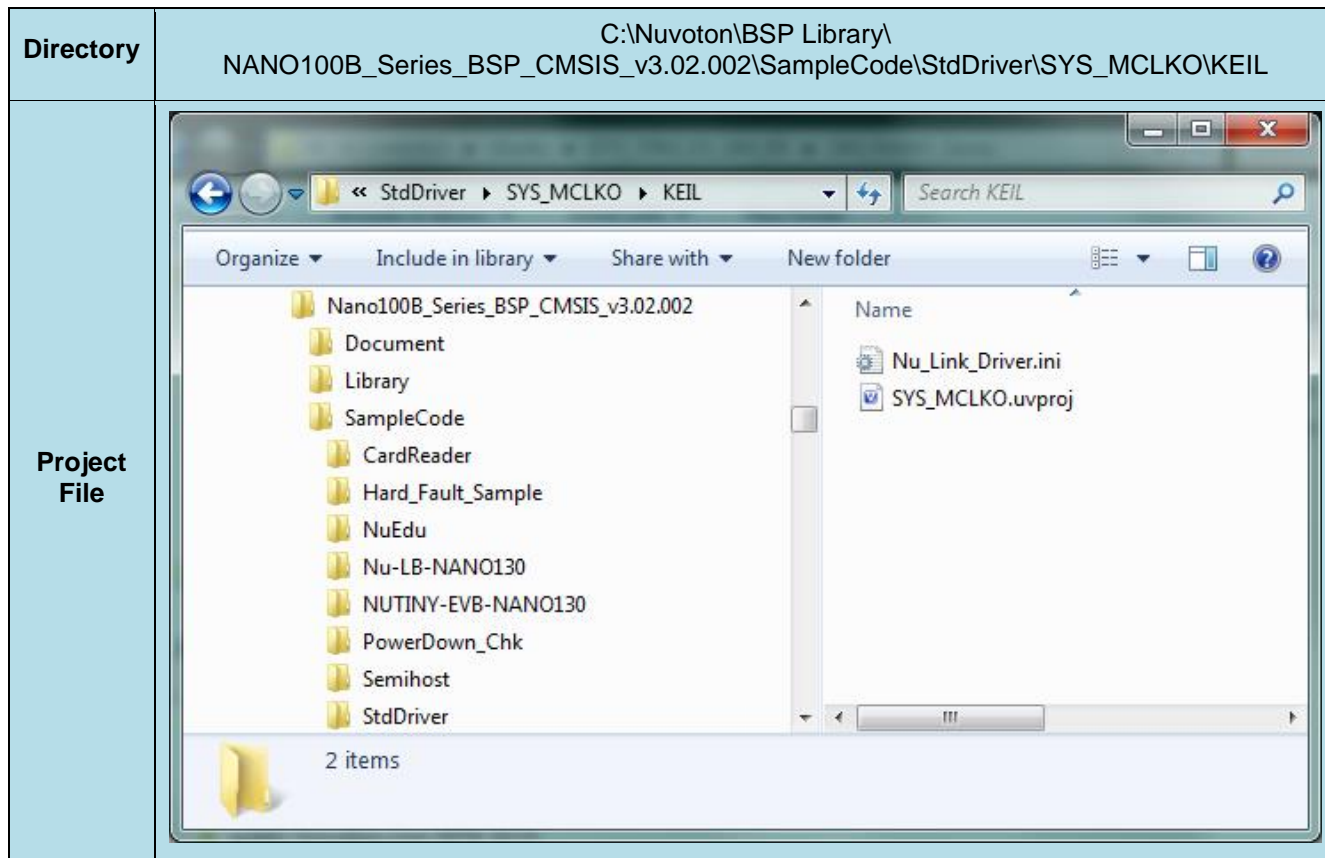









Figure 3-2 Example Directory

To use this example:

This sample code will change module clock and output from PB.12 pin.

-  **Start µVision®**
- **Project-Open**  
Open the SYS.uvproj project file
-  **Project - Build**  
Compile and link the SYS application
-  **Flash – Download**  
Program the application code into on-chip Flash ROM
-  **Start debug mode**  
Using the debugger commands, you may:
  - ◆  Review variables in the watch window
  - ◆  Single step through code
  - ◆  RST Reset the device
  - ◆  Run the application

## 4 HOW TO START NUTINY-SDK-NANO120 ON THE IAR EMBEDDED WORKBENCH

### 4.1 IAR Embedded Workbench Software Download and Install

Please connect to IAR company website (<http://www.iar.com>) to download the IAR Embedded Workbench and install the EWARM.

### 4.2 Nuvoton Nu-Link Driver Download and Install

Please visit the Nuvoton company NuMicro<sup>®</sup> website (<http://www.nuvoton.com/NuMicro>) to download the “NuMicro<sup>®</sup> IAR EWARM Driver” file. When the Nu-Link driver has been well downloaded, please unzip the file and execute the “Nu-Link\_Keil\_Driver.exe” to install the driver.

### 4.3 Hardware Setup

The hardware setup is shown as Figure 4-1.

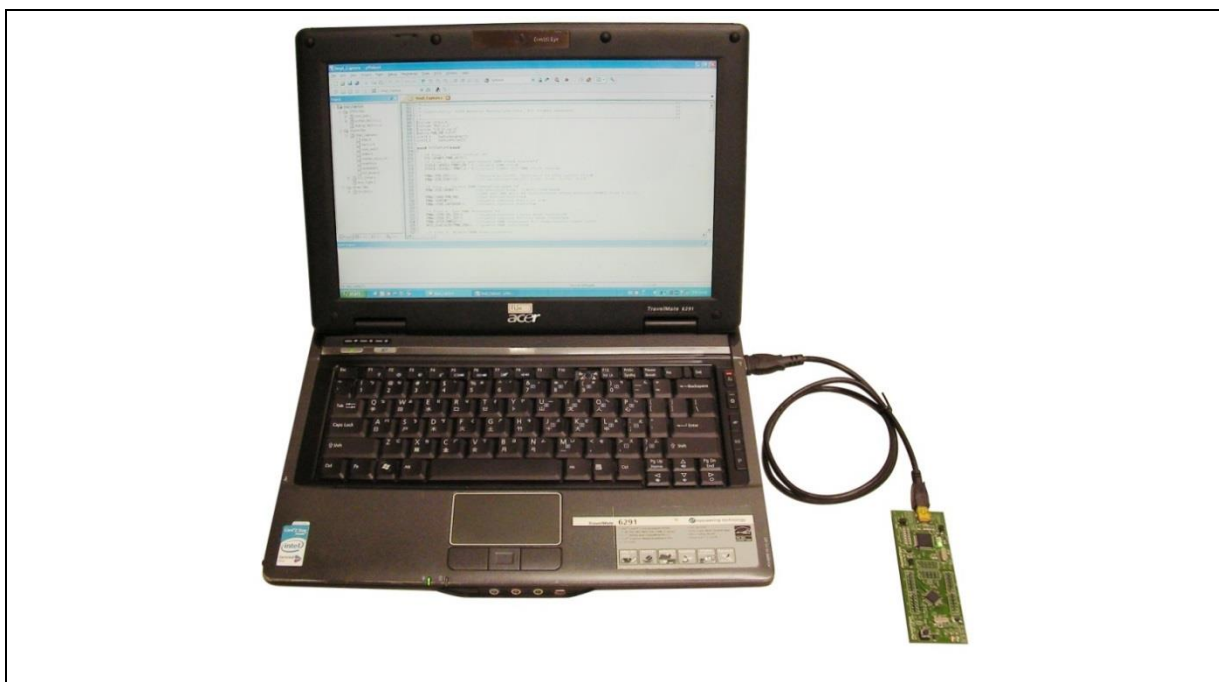

Figure 4-1 NuTiny-SDK-NANO120 Hardware Setup

### 4.4 Example Program

This example demonstrates the ease of downloading and debugging an application on a NuTiny-SDK-NANO120 board. It can be found on Figure 4-2 list directory and downloaded from Nuvoton NuMicro® website.

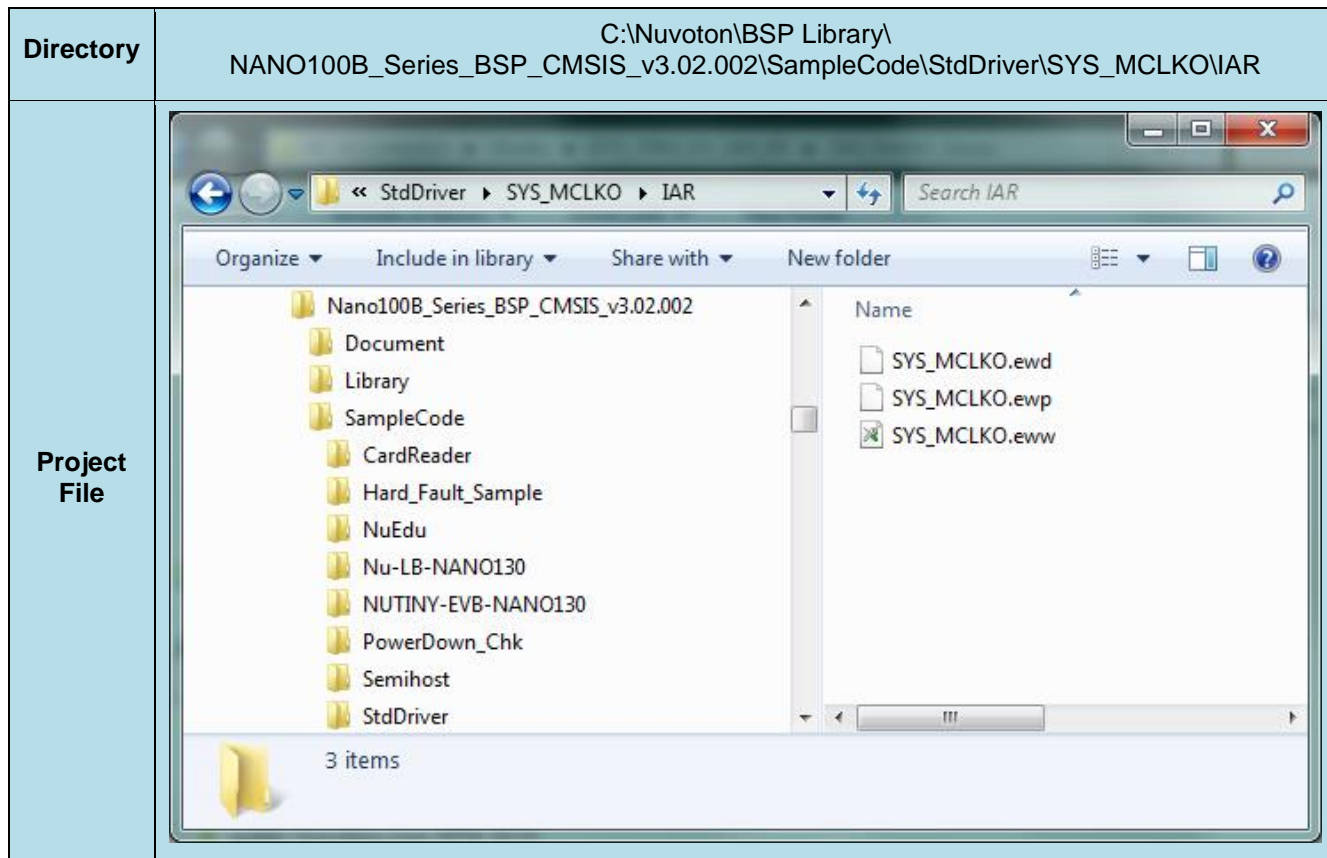







Figure 4-2 Example Directory

To use this example:

This sample code will change module clock and output from PB.12 pin.

-  Start IAR Embedded Workbench
-  Project – Download and Debug  
Program the application code into on-chip Flash ROM
- File-Open-Workspace  
Open the SYS.eww workspace file
-  Single step through code
-  Reset the device
-  Project - Make  
Compile and link the SYS application
-  Run the application

## 5 NUTINY-SDK-NANO120 SCHEMATIC

### 5.1 NuTiny-EVB-NANO120 Schematic

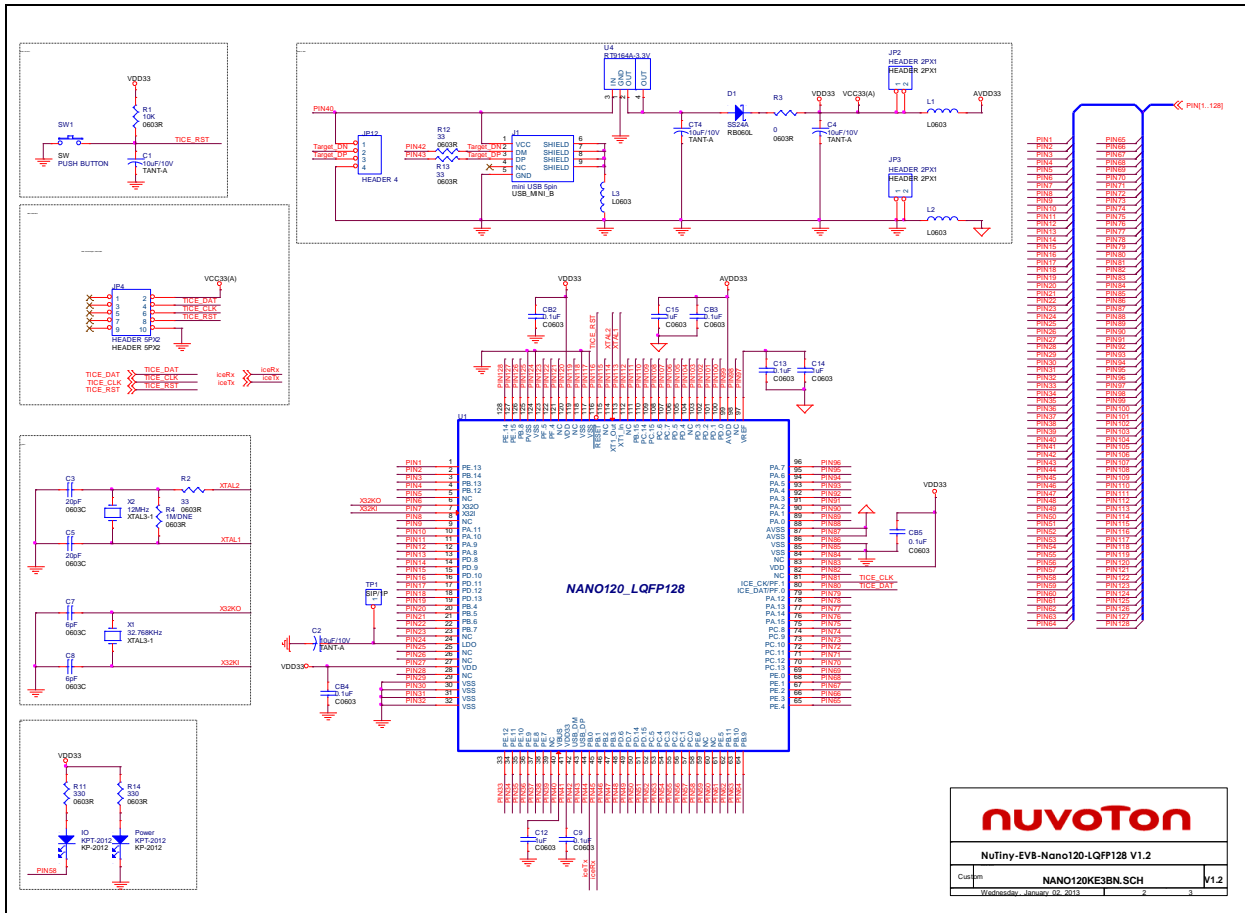

5.2 GPIO for 128 pin Schematic

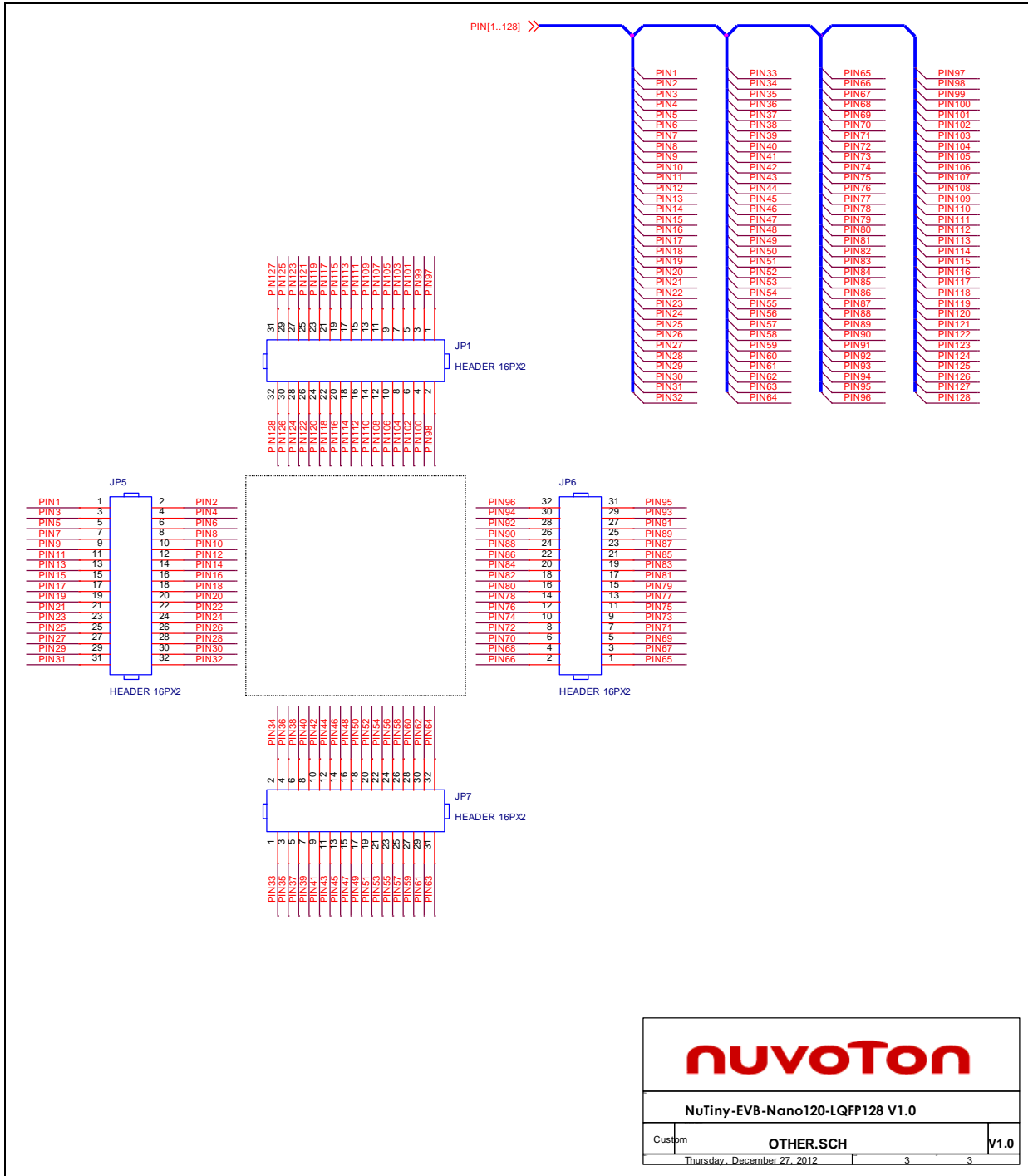

**nuvoTon**

NuTiny-EVB-Nano120-LQFP128 V1.0

Custom	<b>OTHER.SCH</b>	<b>V1.0</b>
Thursday, December 27, 2012		3 3





## 6 REVISION HISTORY

Date	Revision	Description
2018.02.27	1.00	1. Initially issued.

### Important Notice

Nuvoton Products are neither intended nor warranted for usage in systems or equipment, any malfunction or failure of which may cause loss of human life, bodily injury or severe property damage. Such applications are deemed, "Insecure Usage".

Insecure usage includes, but is not limited to: equipment for surgical implementation, atomic energy control instruments, airplane or spaceship instruments, the control or operation of dynamic, brake or safety systems designed for vehicular use, traffic signal instruments, all types of safety devices, and other applications intended to support or sustain life.

All Insecure Usage shall be made at customer's risk, and in the event that third parties lay claims to Nuvoton as a result of customer's Insecure Usage, customer shall indemnify the damages and liabilities thus incurred by Nuvoton.

---

*Please note that all data and specifications are subject to change without notice.  
All the trademarks of products and companies mentioned in this datasheet belong to their respective owners.*