

**Gate resistor installed
Dual N-channel MOSFET**

**KFC4B21320L
Data Sheet**

The information described in this document is the exclusive intellectual property of Nuvoton Technology Corporation Japan and shall not be reproduced without permission from Nuvoton.

*Nuvoton is providing document only for reference purposes of KFC4B21320L based system design.
Nuvoton assumes no responsibility for errors or omissions.
All data and specifications are subject to change without notice.*

For additional information or question, please contact Nuvoton Technology Corporation Japan.
www.nuvoton.co.jp

1. GENERAL DESCRIPTION

Gate resistor installed Dual N-channel MOSFET
For lithium-ion secondary battery protection circuits

2. FEATURES

- Low source-source ON resistance: $R_{ss(on)}$ typ. = 36 mΩ (VGS = 4.5 V)
- CSP (Chip Size Package)
- RoHS compliant (EU RoHS / MSL: Level 1 compliant)

3. MARKING SYMBOL: 2D

4. PACKAGING

Embossed type (Thermo-compression sealing): 20,000 pcs / reel (standard)

5. ABSOLUTE MAXIMUM RATINGS $T_a = 25\text{ }^\circ\text{C}$

Parameter	Symbol	Rating	Unit
Source-source Voltage	VSS	12	V
Gate-source Voltage	VGS	±8	V
Source Current (DC)	IS1 *1	2.5	A
	IS2 *2	4	A
Source Current (Pulsed)	ISp *3	25	A
Total Power Dissipation	PD1 *1	0.34	W
	PD2 *2	0.9	W
Channel Temperature	Tch	150	°C
Storage Temperature Range	Tstg	-55 to +150	°C

6. THERMAL CHARACTERISTICS $T_a = 25\text{ }^\circ\text{C}$

Parameter	Symbol	Rating	Unit
Thermal Resistance (ch-a)	Rth1 *1	368	°C / W
	Rth2 *2	139	°C / W

- Note *1 Mounted on FR4 board (25.4 mm x 25.4 mm x t1.0 mm), using the minimum recommended pad size (36µm Copper).
*2 Mounted on Ceramic substrate (70 mm x 70 mm x t1.0 mm).
*3 $t = 10\text{ }\mu\text{s}$, Duty Cycle $\leq 1\%$

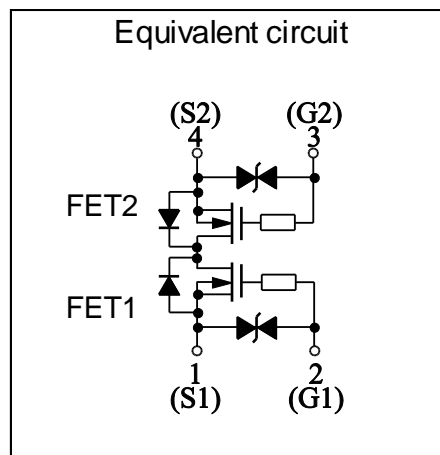
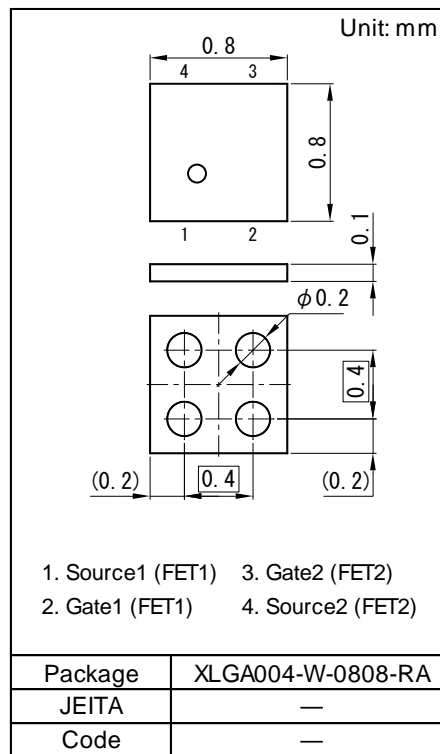

7. ELECTRICAL CHARACTERISTICS Ta = 25 °C ± 3 °C

Parameter	Symbol	Conditions	Min	Typ	Max	Unit
Source-source Breakdown Voltage	VSSS	IS = 1 mA, VGS = 0 V	12			V
Zero Gate Voltage Source Current	ISSS	VSS = 12 V, VGS = 0 V			1.0	μA
Gate-Source Leakage Current	IGSS	VGS = ±8 V, VSS = 0 V			±10	μA
		VGS = ±5 V, VSS = 0 V			±1.0	
Gate-source Threshold Voltage	Vth	IS = 0.07 mA, VSS = 10 V	0.35	0.90	1.40	V
Source-source On-state Resistance	RSS(on)1	IS = 1.25 A, VGS = 4.5 V	27	36	48	mΩ
	RSS(on)2	IS = 1.25 A, VGS = 3.8 V	29	39	53	
	RSS(on)3	IS = 1.25 A, VGS = 3.1 V	32	45	75	
	RSS(on)4	IS = 1.25 A, VGS = 2.5 V	35	58	115	
Body Diode Forward Voltage	VF(s-s)	IF = 1.25 A, VGS = 0 V		0.6	1.2	V
Input Capacitance *1	Ciss	VSS = 10 V, VGS = 0 V, f = 1 kHz		205		pF
Output Capacitance *1	Coss			50		
Reverse Transfer Capacitance *1	Crss			40		
Turn-on delay Time *1,*2	td(on)	VDD = 10 V, VGS = 0 to 4 V		0.10		μs
Rise Time *1,*2	tr	IS = 1.25 A		0.15		
Turn-off delay Time *1,*2	td(off)	VDD = 10 V, VGS = 4 to 0 V		0.50		μs
Fall Time *1,*2	tf	IS = 1.25 A		0.30		
Total Gate Charge *1	Qg	VDD = 10 V		3.5		nC
Gate-source Charge *1	Qgs	VGS = 0 to 4 V		0.8		
Gate-drain Charge *1	Qgd	IS = 1.25 A		1.0		

Note Measuring methods are based on JAPANESE INDUSTRIAL STANDARD JIS C 7030 Measuring methods for transistors.

*1 Guaranteed by design, not subject to production testing

*2 Measurement circuit for Turn-on Delay Time / Rise Time / Turn-off Delay Time / Fall Time

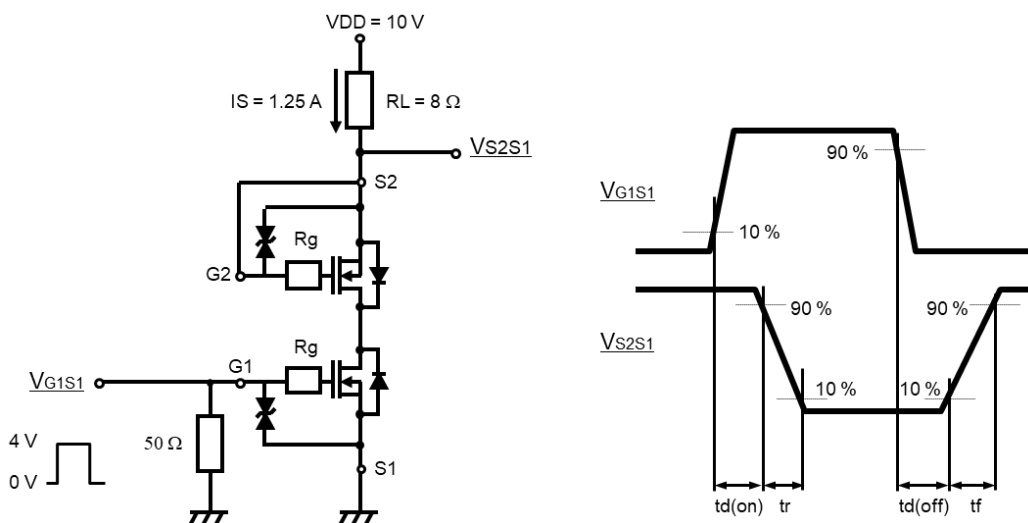

8. TECHNICAL DATA (Reference)

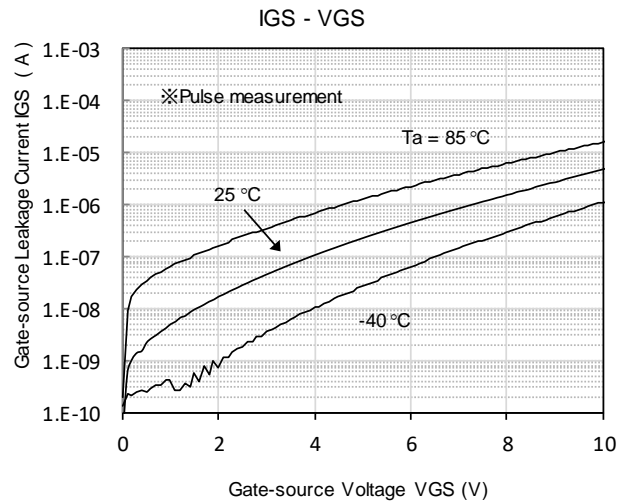
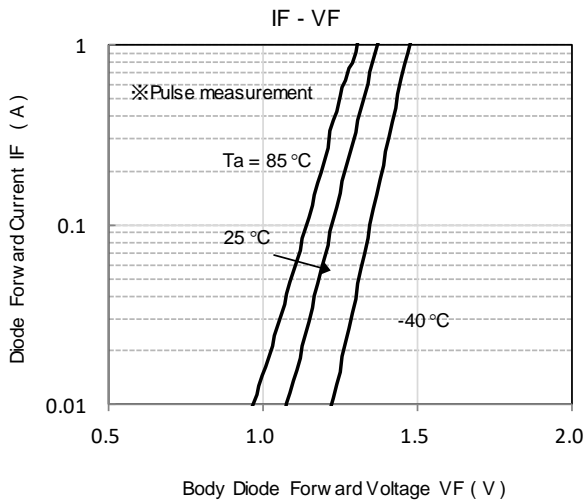
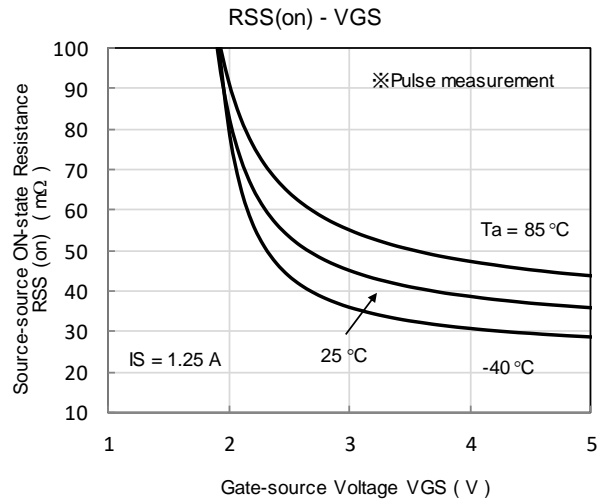
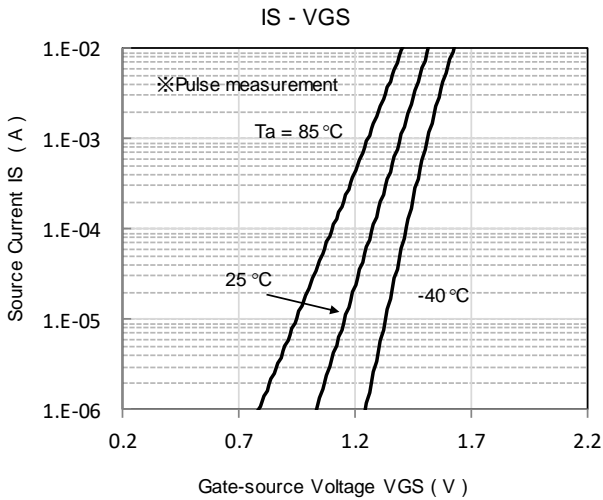
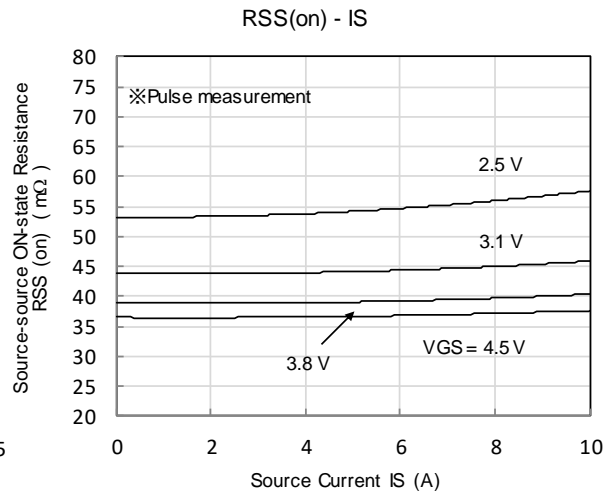
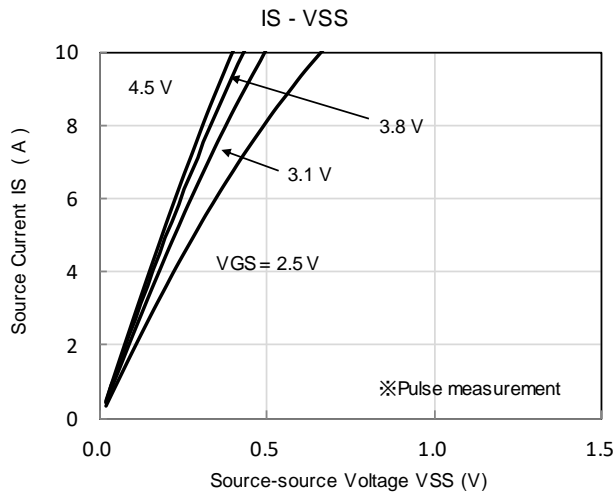

TECHNICAL DATA (Reference)

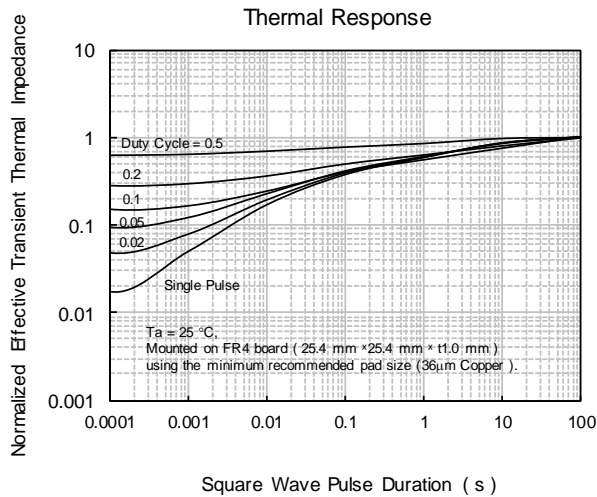
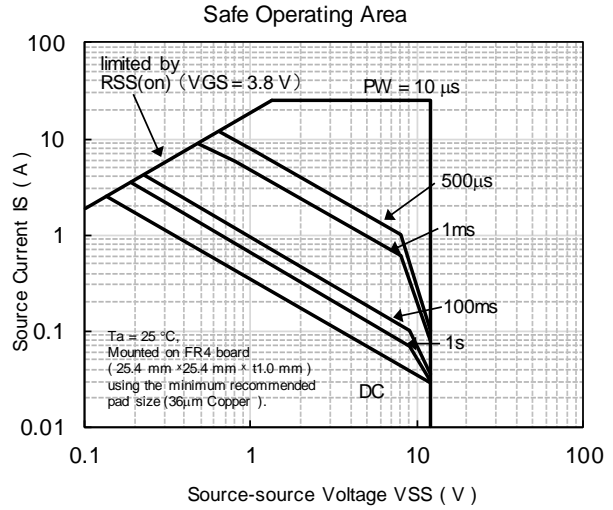
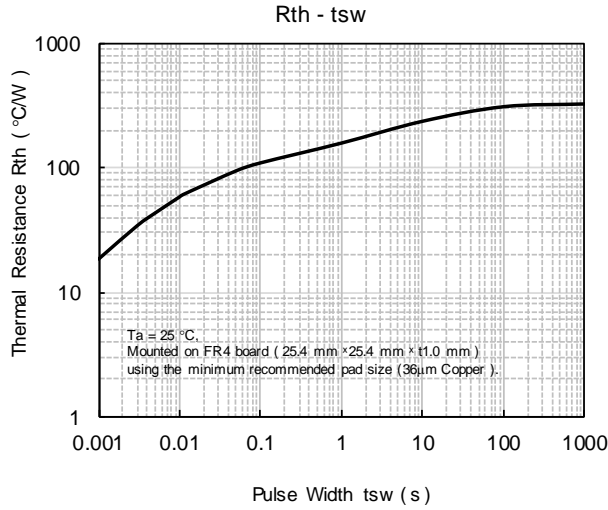
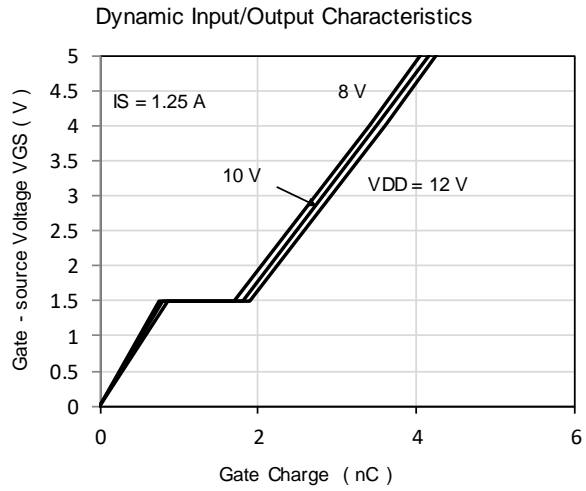
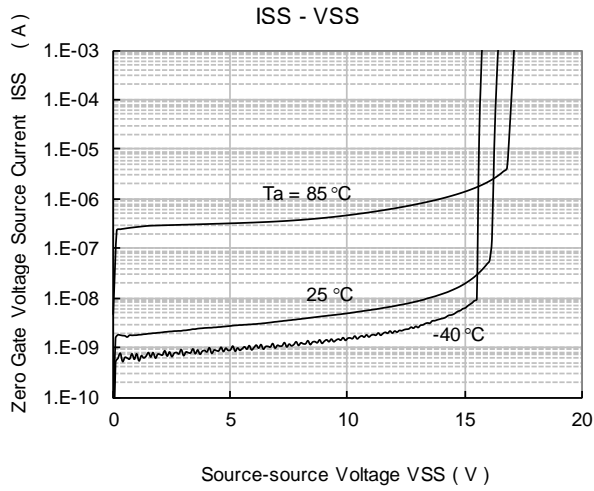

9. OUTLINE

Unit : mm

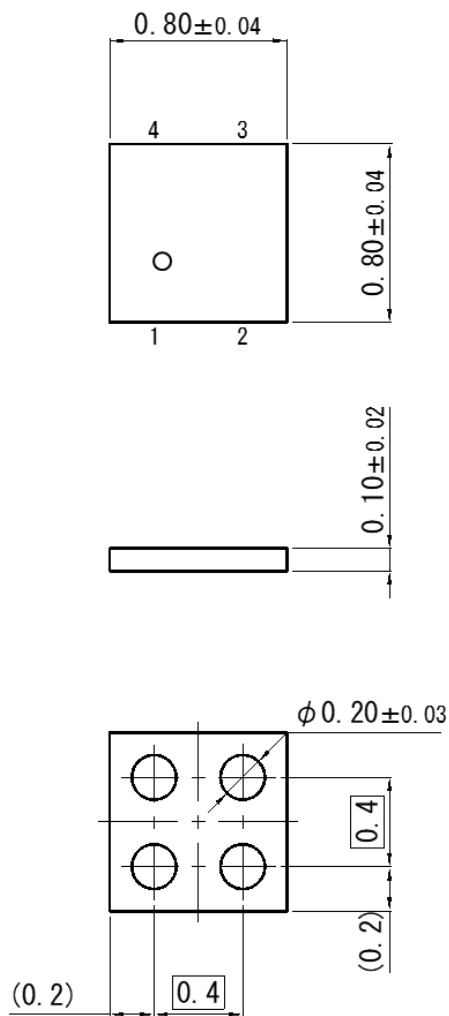

10. LAND PATTERN (Reference)

Unit : mm

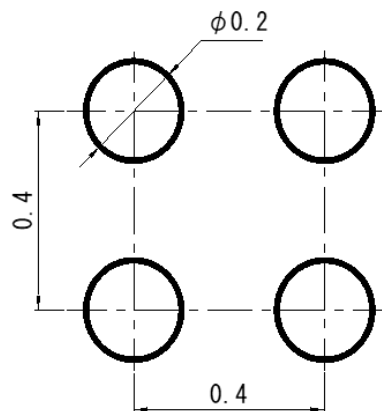

11. REVISION HISTORY

Date	Revision	Description
2021.2.5	1.00	1. initially issued.

Important Notice

Nuvoton Products are neither intended nor warranted for usage in systems or equipment, any malfunction or failure of which may cause loss of human life, bodily injury or severe property damage. Such applications are deemed, "Insecure Usage".

Insecure usage includes, but is not limited to: equipment for surgical implementation, atomic energy control instruments, airplane or spaceship instruments, the control or operation of dynamic, brake or safety systems designed for vehicular use, traffic signal instruments, all types of safety devices, and other applications intended to support or sustain life.

All Insecure Usage shall be made at customer's risk, and in the event that third parties lay claims to Nuvoton as a result of customer's Insecure Usage, customer shall indemnify the damages and liabilities thus incurred by Nuvoton.

*Please note that all data and specifications are subject to change without notice.
All the trademarks of products and companies mentioned in this datasheet belong to their respective owners.*